





























**NEW**

microgel 4



														
		°C	mm. (LxPxH)	DI SERIE	MAX	Watt		H <sub>2</sub> O	230v/1/50Hz		R404a	Kg.		LED di serie
<b>NEW</b> Microgel 2		-15/-18	722x560x467	-	n° 4 - Lt. 2,5 o n° 2 - Lt. 5 / Lt. 7	550		MAN	230v/1/50Hz		R404a	37	-	LED di serie
<b>NEW</b> Microgel 3		-15/-18	897x560x467	-	n° 6 - Lt. 2,5 o n° 3 - Lt. 5 / Lt. 7	550		MAN	230v/1/50Hz		R404a	44	-	LED di serie
<b>NEW</b> Microgel 4		-15/-18	1072x560x467	-	n° 8 - Lt. 2,5 o n° 4 - Lt. 5 / Lt. 7	550		MAN	230v/1/50Hz		R404a	50	-	LED di serie

Dati di collaudo • Test details • Détails d'essai • Prüfungsergebnisse • Datos de ensayo • MAX = (25°C - % U.R. 60)

Prezzi vedi LISTINO a pagina 4  
See PRICE LIST on page 4

microgel 3 GN



Colori standard  
Standard colors



COD. 08

		°C	mm. (LxPxH)	<b>DI SERIE</b>	<b>MAX</b>	Watt	DEFROST	H <sub>2</sub> O				Kg.		
<b>NEW</b>	Microgel 2 GN	+2/+8	722x560x467	-	n° 2 - GN 1/3 h. 100 o 150 mm.	400		MAN	230v/1/50Hz		R404a	37	-	LED di serie
<b>NEW</b>	Microgel 3 GN	+2/+8	897x560x467	-	n° 3 - GN 1/3 h. 100 o 150 mm.	400		MAN	230v/1/50Hz		R404a	44	-	LED di serie
<b>NEW</b>	Microgel 4 GN	+2/+8	1072x560x467	-	n° 4 - GN 1/3 h. 100 o 150 mm.	400		MAN	230v/1/50Hz		R404a	50	-	LED di serie

Dati di collaudo • Test details • Détails d'essai • Prüfungsergebnisse • Datos de ensayo • MAX = (25°C - % U.R. 60)

Prezzi vedi LISTINO a pagina 4  
See PRICE LIST on page 4



minigel



Leds di serie  
LEDs standard

Colori standard  
Standard colors



COD. 09

dominante 100 g



Colori standard  
Standard colors



COD. 09

	°C	mm. (LxPxH)	Lt.	<b>DI SERIE</b>	Watt	% U.R.	DEFROST	H <sub>2</sub> O				Kg.		
Minigel	-18	610x515x750	55	n° 1 mm. 340x470 n° 1 mm. 150x470	183	65		MAN	230v/1/50Hz		R134a	45	-	LED di serie
Dominante 100 G	+4/+10	1052x436x510	100	n° 2 mm. 710x320	260	80		AUT	230v/1/50Hz		R134a	42	-	di serie

Dati di collaudo • Test details • Détails d'essai • Prüfungsergebnisse • Datos de ensayo • MAX = (25°C - % U.R. 60)



Prezzi vedi LISTINO a pagina 4  
See PRICE LIST on page 4

puntogel 50



puntogel 90



Colori standard  
Standard colors















COD. 09

puntogel 50 spot



puntogel 90 spot



													
	°C	mm. (LxPxH)	Lt.	<b>DI SERIE</b>	Watt	DEFROST	H <sub>2</sub> O				Kg.		
Puntogel 50	-18	570x530x520	50	n° 2 mm. 440x210	154	MAN	230v/1/50Hz		R134a	40	Di serie	LED di serie	
Puntogel 90	-18	610x580x670	90	n° 2 mm. 488x420 n° 1 mm. 488x200	190	MAN	230v/1/50Hz		R134a	49	Di serie	LED di serie	
Puntogel 50 Spot	-18	570x545x637	50	n° 2 mm. 440x210	150	MAN	230v/1/50Hz		R134a	42	Di serie	LED di serie	
Puntogel 90 Spot	-18	610x555x892	116	n° 3 mm. 488x420	220	MAN	230v/1/50Hz		R134a	54	Di serie	LED di serie	

Dati di collaudo • Test details • Détails d'essai • Prüfungsergebnisse • Datos de ensayo • MAX = (25°C - % U.R. 60)

Prezzi vedi LISTINO a pagina 4-5  
See PRICE LIST on page 4-5



MICROGEL

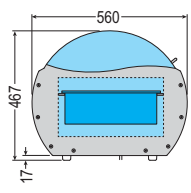
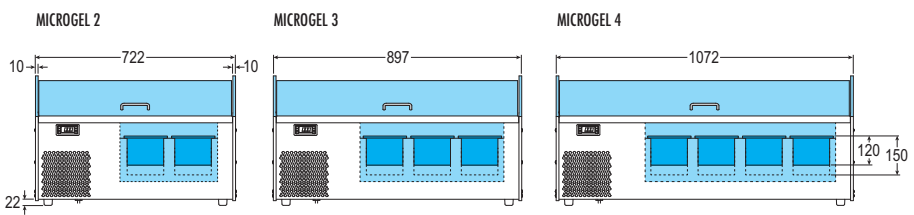

ACCESSORI / ACCESSORIES:

- Lt. 2,5 - mm 180 x 165 h. 120
- Lt. 5 - mm 360 x 165 h. 120
- Lt. 7 - mm 360 x 165 h. 150

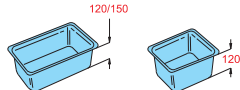

Le vaschette sono fornite a richiesta  
Basins are available on request

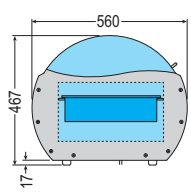
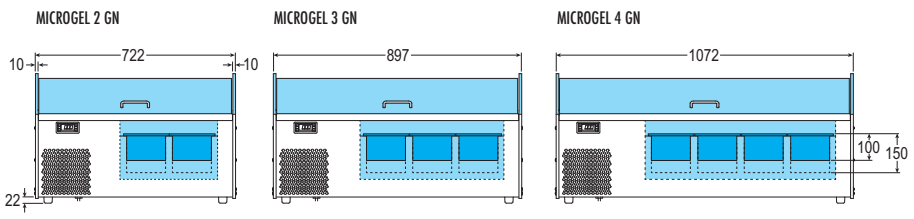

ACCESSORI / ACCESSORIES:

- GN 1/3 = mm. 325 x 175 h. 100
- GN 1/3 = mm. 325 x 175 h. 150

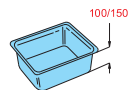

Le vaschette sono fornite a richiesta  
Basins are available on request

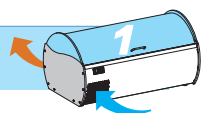

MINIGEL

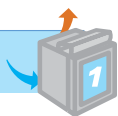
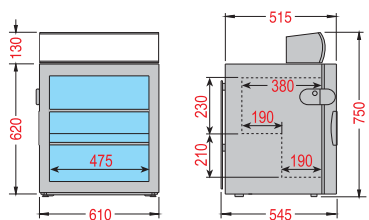

DOMINANTE 100 G

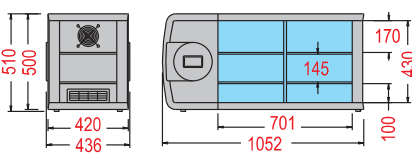

PUNTOGEL 50

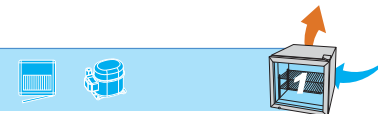
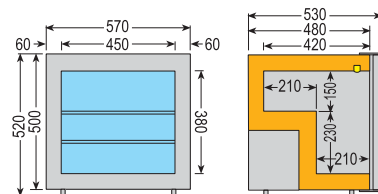

PUNTOGEL 90

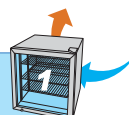
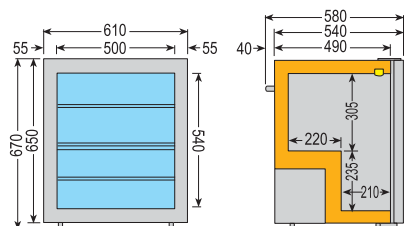

PUNTOGEL 50 SPOT

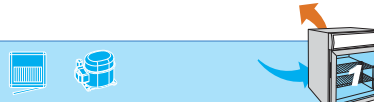
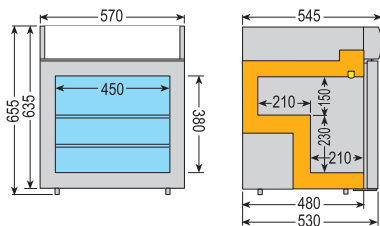

PUNTOGEL 90 SPOT

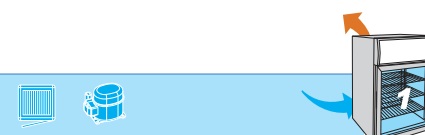
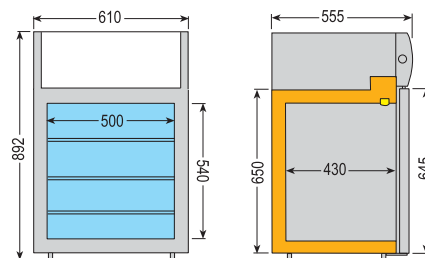

Linus 150



Colori standard  
Standard colors  
  
COD. 53

Struttura inox + alluminio lucido / *Stainless steel frame + polished aluminium*  
Structure inox + aluminium brillant / *Inox Struktur + Aluminium weiß* / Estructura en acero inox + aluminio lustroso

														
	°C	mm. (LxPxH)	Lt.	<b>DI SERIE</b>	Watt	% U.R.	DEFROST	H <sub>2</sub> O				Kg.		
Linus 100		800x438x734	100	n° 1 mm. 685x292	320	70		AUT	230v/1/50Hz		R404a	70	-	Led di serie
Linus 150		800x438x934	160	n° 2 mm. 685x292	320	70		AUT	230v/1/50Hz		R404a	85	-	Led di serie
Linus 200		1000x438x934	200	n° 2 mm. 899x292	320	70		AUT	230v/1/50Hz		R404a	95	-	Led di serie

Dati di collaudo • Test details • Détails d'essai • Prüfungsergebnisse • Datos de ensayo • MAX = (25°C - % U.R. 60)

Prezzi vedi LISTINO a pagina 5  
See PRICE LIST on page 5



Linus 842 dry



Colori standard  
Standard colors



COD. 53

Cassetto per inserimento acqua  
Tray for water  
Bac à eau  
Tablett mit Wasser  
Bandeja para agua



Struttura inox  
Stainless steel frame  
Structure inox  
Inox Struktur  
Estructura en acero inox

		°C	mm. (LxPxH)	Lt.	DI SERIE	Watt	% U.R.	DEFROST				Kg.		
Linus 642 Dry		+30/+65	625x420x485	80	n° 1 mm. 578x330	700	70	-	230v/1/50Hz	-	-	26	-	-
Linus 842 Dry		+30/+65	825x420x485	100	n° 1 mm. 778x330	700	70	-	230v/1/50Hz	-	-	29	-	-
Linus 1042 Dry		+30/+65	1025x420x485	120	n° 1 mm. 978x330	700	70	-	230v/1/50Hz	-	-	38	-	-

Dati di collaudo • Test details • Détails d'essai • Prüfungsergebnisse • Datos de ensayo • MAX = (25°C - % U.R. 60)



Prezzi vedi LISTINO a pagina 5  
See PRICE LIST on page 5



viennetta R2U

VETRINETTE NEUTRE E RISCALDATE DA BANCO PER BRIOCHES  
 DISPLAY CASES NEUTRAL AND HEATED FOR CROISSANTS



Termostato meccanico esterno  
 Mechanical external thermostat

Tasto on-off  
 On-off switch

Cassetto in acciaio inox per l'acqua, permette di umidificare la vetrina ed evitare l'essiccamento dei prodotti esposti / *Stainless-steel tray for water, it allows to humidify the display case and to prevent drying of the exposed products*



viennetta n

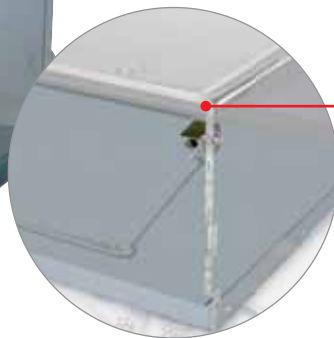

Fianchi e portine in PMMA antiurto ad alta trasparenza / *Sides and doors in PMMA, shockproof and high transparency*

		°C	mm. (LxPxH)	Watt		Kg.
<b>NEW</b> Viennetta N1		Ambient	508x365x180	-	-	5
<b>NEW</b> Viennetta N2		Ambient	508x365x328	-	-	7
<b>NEW</b> Viennetta R1U		+30/+60	510x369x234	200	230v/1/50Hz	7
<b>NEW</b> Viennetta R2U		+30/+60	510x369x382	200	230v/1/50Hz	10

Struttura in lamiera acciaio inox 430 a finitura lucida / *The structure is in stainless-steel 430 sheet, polished finish*

Resistenza corazzata inox, controllata da un termostato fino 90° C e interruttore luminoso / *Armored resistance in stainless-steel, controlled by a thermostat until 90°C and light switch*

Colori standard  
 Standard colors



Dati di collaudo • Test details • Détails d'essai • Prüfungsergebnisse • Datos de ensayo • MAX = (25°C - % U.R. 60)

Prezzi vedi LISTINO a pagina 5-6  
 See PRICE LIST on page 5-6



LINUS 100

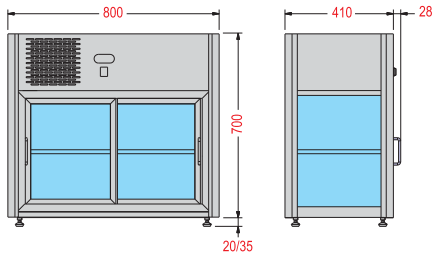

LINUS 150

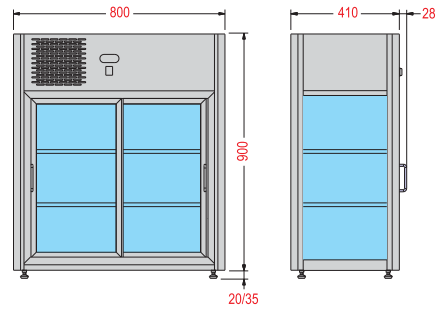

LINUS 200

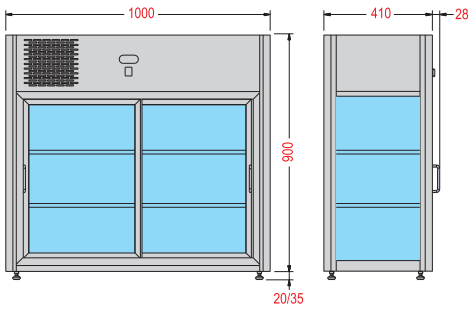

OPTIONAL:

Porte scorrevoli su entrambe i lati  
Sliding doors on both sides

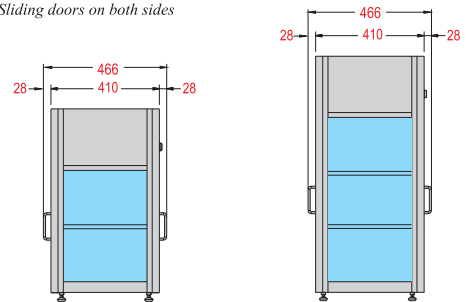

LINUS 642 DRY

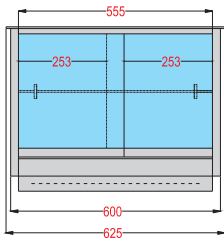

LINUS 842 DRY

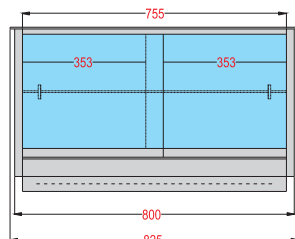

LINUS 1042 DRY

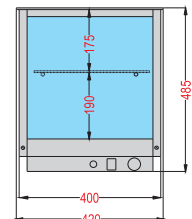
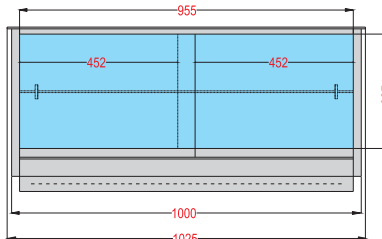

VIENNETTA N1

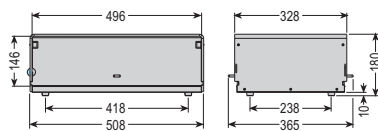

VIENNETTA N2

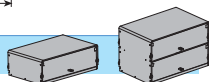
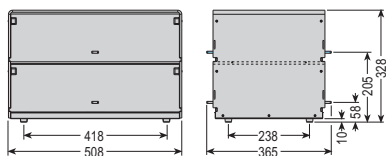

VIENNETTA R1U

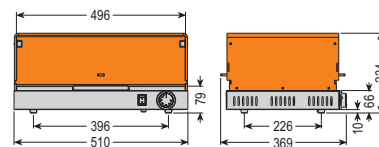

VIENNETTA R2U

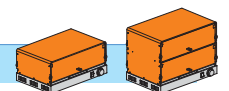
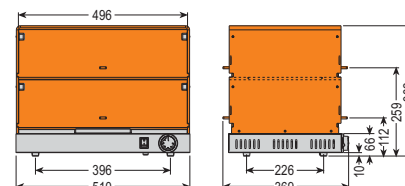

orizont  
100 q  
Argento

Colore di serie: bronzo  
Standard colour: bronze  
Couleur standards: bronze  
Standardfarbe: Bronze  
Color estándar: bronce



orizont  
150 q



orizont  
200 q  
Argento

Colore di serie: bronzo  
Standard colour: bronze  
Couleur standards: bronze  
Standardfarbe: Bronze  
Color estándar: bronce



# orizont

## Il fascino delle linee classiche

**ORIZONT** è una linea di piccoli espositori orizzontali, nata per completare e/o implementare i banconi bar.

La gamma Orizont comprende tre espositori a temperatura positiva (**100 Q**, **150 Q**, **200 Q** con capacità di 100, 150 e 200 litri rispettivamente), un espositore self service a temperatura positiva (**200 Q SS**), un espositore negativo (**200 GBT**), un espositore neutro (**200 Q Neutral**) e addirittura un espositore riscaldato (**202 Q Hot**).

Tutti questi prodotti sono riconoscibili dall'inconfondibile profilo curvo Tecfrigo, nei classici ed eleganti colori bronzo e argento. Per rendere speciale il vostro espositore, comunque, tutte le vetrine sono personalizzabili a richiesta con una vasta scelta di colori RAL.



orizont 200 q ss



## The charm of classic design

**ORIZONT** is a line of small horizontal exhibitors, born to complete and/or implement bar counters.

The Orizont range includes three positive temperature exhibitors (**100 Q**, **Q 150**, **Q 200** with a capacity of respectively 100, 150 and 200 liters), a self-service positive temperature displayer (**200 Q SS**), a negative displayer (**200 GBT**), a neutral displayer (**200 Q neutral**) and even a heated displayer (**202 Q Hot**).

All these products are recognizable by the unmistakable curved Tecfrigo profiles, available in the classic and elegant bronze or silver colors. However, to make them special, all the exhibitors are customizable on request with a wide range of RAL paintings.



orizont 200 q hot

orizont 200 q neutral



# orizont 200 q SELF SERVICE

## Argento

Colore di serie: bronzo / *Standard colour: bronze* / *Couleur standards: bronze* / *Standardfarbe: Bronze* / *Color estándar: bronze*



Con porte scorrevoli e basculanti Self Service  
With sliding and Self Service up-and-over doors

		°C	mm. (LxPxH)	Lt.	DI SERIE	Watt	% U.R.	DEFROST	H <sub>2</sub> O			Kg.		
Orizont 100 Q		+4/+10	1000x390x515	100	n° 2 mm. 600x275	350	75		AUT	230v/1/50Hz		R134a	54	Optional di serie
Orizont 150 Q		+4/+10	1100x450x615	150	n° 2 mm. 665x330	353	75		AUT	230v/1/50Hz		R134a	72	Optional di serie
Orizont 200 Q		+4/+10	1200x528x725	200	n° 3 mm. 765x380	498	75		AUT	230v/1/50Hz		R404a	92	Optional di serie
Orizont 200 Q Self Service		+4/+10	1200x528x725	200	n° 3 mm. 765x380	498	75		AUT	230v/1/50Hz		R404a	83	Optional di serie
Orizont 200 GBT		-5/-18	1200x543x725	200	n° 2 mm. 740x400	550	45		MAN	230v/1/50Hz		R404a	100	- di serie
Orizont 200 Q Neutral		AMBIENT	900x528x725	200	n° 2 mm. 875x410	50	-	-	-	230v/1/50Hz	-	-	42	- di serie
Orizont 202 Q Hot		+35/+70	900x500x725	200	n° 2 mm. 830x490	1220	-	-	-	230v/1/50Hz	-	-	35	- di serie

Dati di collaudo • Test details • Détails d'essai • Prüfungsergebnisse • Datos de ensayo • MAX = (25°C - % U.R. 60) • **Orizont 200 GBT: MAX = (30°C - % U.R. 55)**



Prezzi vedi LISTINO a pagina 6  
See PRICE LIST on page 6

orizont 200 GBT



orizont 200 q neutral Argento



Porte basculanti Self Service sul lato cliente  
Self Service doors on client side

orizont 202 q hot Argento



Lampade riscaldanti  
Warming lamps  
Lampes chauffantes  
Heizungslampen  
Lamparas calentadoras



ORIZONT 100 Q

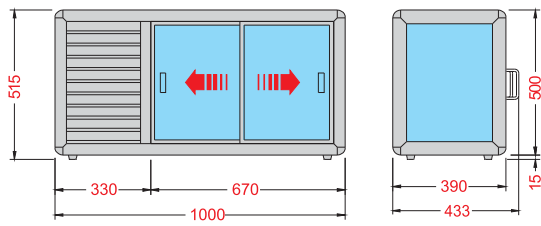

ORIZONT 150 Q

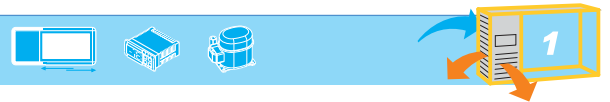
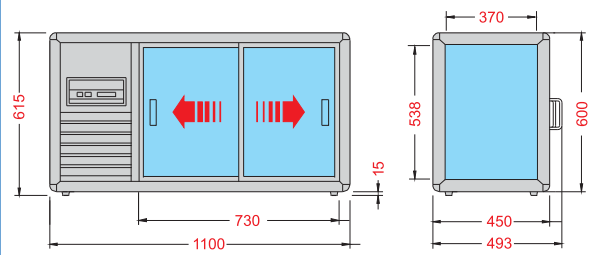

ORIZONT 200 Q Self Service

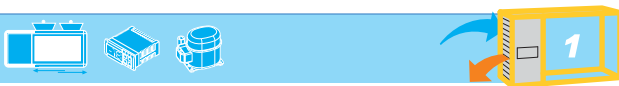
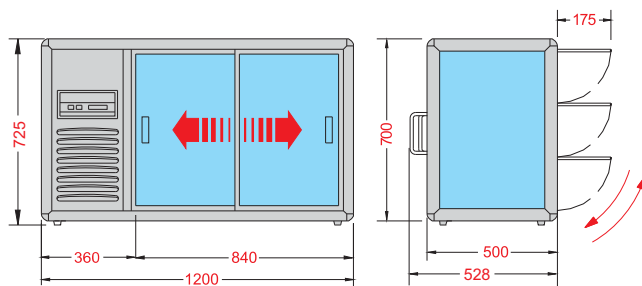

ORIZONT 200 Q

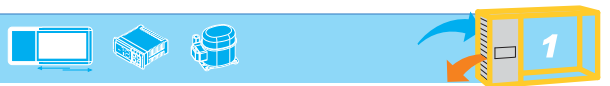
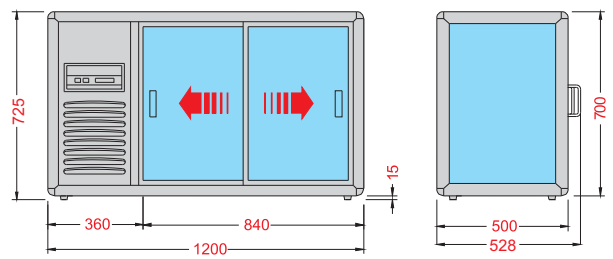

ORIZONT 202 Q Hot

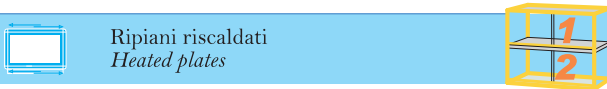
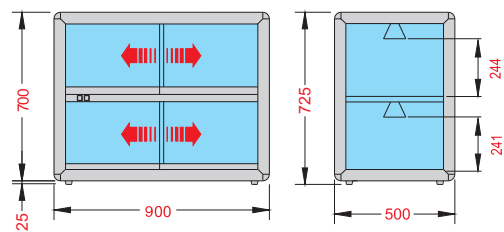

ORIZONT 200 Q Neutral

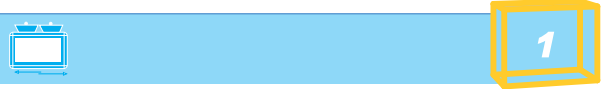
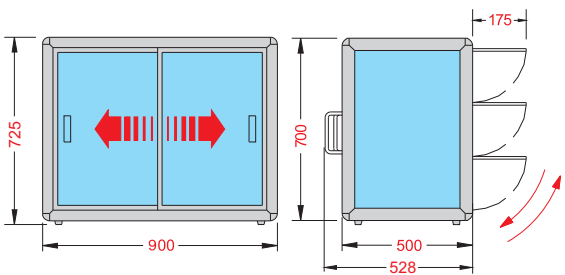

ORIZONT 200 GBT

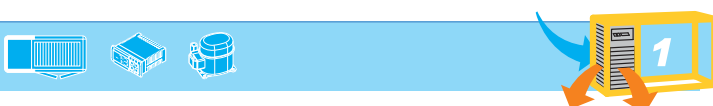
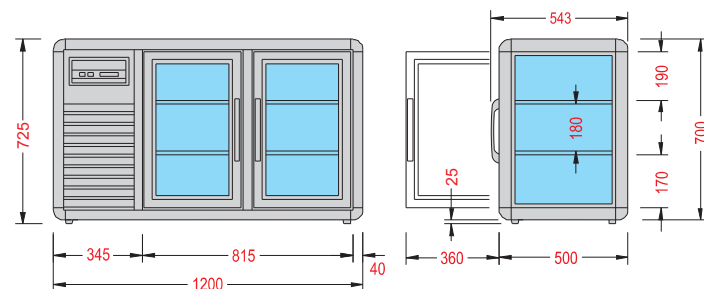

snoopino



Porte scorrevoli  
Sliding doors



Leds di serie  
LEDs standard



Porte scorrevoli  
Sliding doors

N° 2 ripiani in plexiglass  
No. 2 plexiglass shelves

Colori standard  
Standard colors

Colori optional  
Optional colors



COD. 02



COD. 01



RAL

(da incasso / built in / encastrable / zum einbauen / de encastre)

	°C	mm. (LxPxH)	Lt.		<b>DI SERIE</b>	Watt	% U.R.		H <sub>2</sub> O			Kg.		LED di serie
Snoopino	+4/+10	730x528x930	190	n° 2 mm. 400x635		340	75		AUT	230v/1/50Hz		R404a	80	Optional

Dati di collaudo • Test details • Détails d'essai • Prüfungsergebnisse • Datos de ensayo • MAX = (25°C - % U.R. 60)

Prezzi vedi LISTINO a pagina 6  
See PRICE LIST on page 6



snoopy Q



Leds di serie  
LEDs standard



Porte scorrevoli  
Sliding doors

N° 2 ripiani in plexiglass  
No. 2 plexiglass shelves

Colori standard Standard colors	Colori optional Optional colors
COD. 02	COD. 01 RAL

(da incasso / built in / encastrable / zum einbauen / de encastre)

	°C	mm. (LxPxH)	Lt.	<b>DI SERIE</b>	Watt	% U.R.	DEFROST	H <sub>2</sub> O			Kg.			LED di serie
Snoopy Q	+4/+10	900x528x930	200	n° 2 mm. 774x404	340	75		AUT	230v/1/50Hz		R404a	90	Optional	LED di serie

Dati di collaudo • Test details • Détails d'essai • Prüfungsergebnisse • Datos de ensayo • MAX = (25°C - % U.R. 60)

**Prezzi vedi LISTINO a pagina 7**  
See PRICE LIST on page 7

snoopy GBT



Leds di serie  
LEDs standard



Evaporatore statico a  
griglie fisse (n° 2)  
Static evaporator with  
fixed shelves (No. 2)

Colori standard Standard colors	Colori optional Optional colors	
COD. 02	COD. 01	RAL

(da incasso / built in / encastrable / zum einbauen / de encastre)

						% U.R. icon"/>								
Snoopy GBT	°C	mm. (LxPxH)	Lt.	<b>DI SERIE</b>	Watt	% U.R.	DEFROST	H <sub>2</sub> O			Kg.			LED di serie
	-5/-18	910x540x930	200	n° 2 mm. 740x400	550	45		MAN	230v/1/50Hz		R404a	100	Optional	

Dati di collaudo • Test details • Détails d'essai • Prüfungsergebnisse • Datos de ensayo • MAX = (30°C - % U.R. 55)

Prezzi vedi LISTINO a pagina 7  
See PRICE LIST on page 7



**SNOOPINO**

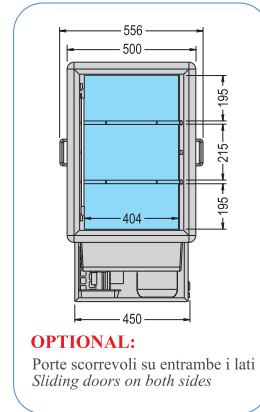
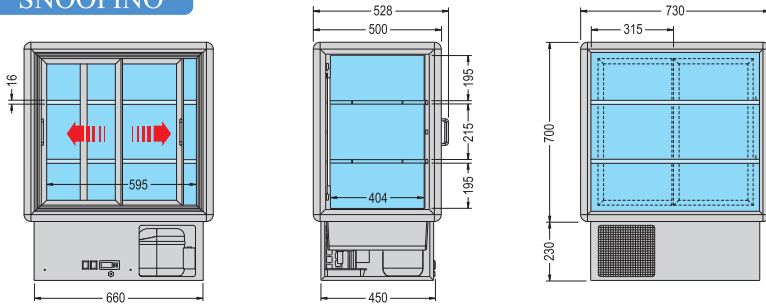

**OPTIONAL:**  
Porte scorrevoli su entrambe i lati  
*Sliding doors on both sides*



**SNOOPY Q**

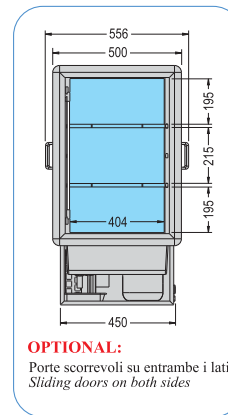
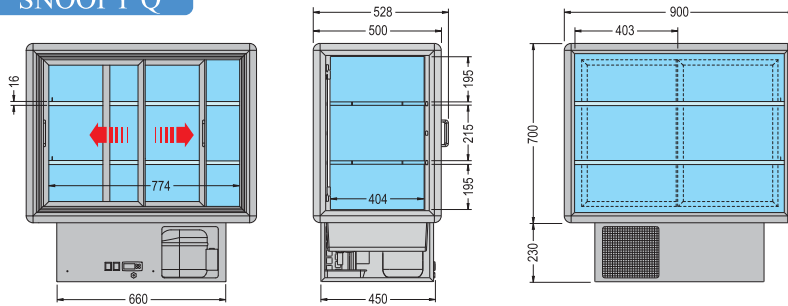

**OPTIONAL:**  
Porte scorrevoli su entrambe i lati  
*Sliding doors on both sides*

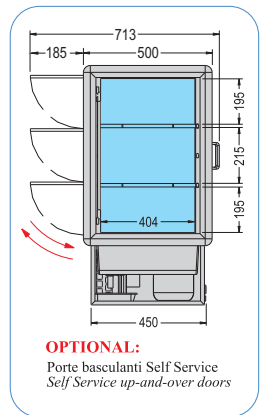

**OPTIONAL:**  
Porte basculanti Self Service  
*Self Service up-and-over doors*

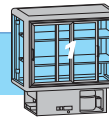

**SNOOPY GBT**

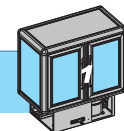
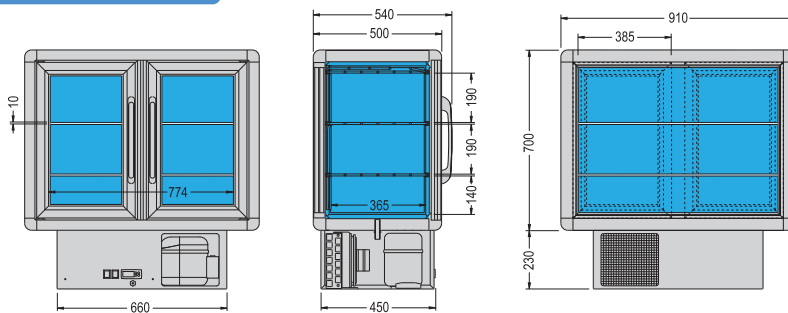

(DA INCASSO / BUILT IN / ENCASTRABLE / ZUM EINBAUEN / DE ENCASTRE)

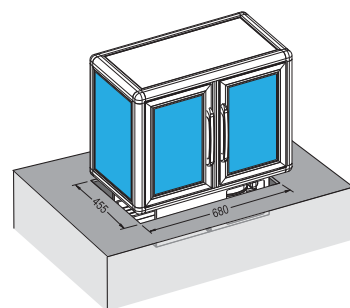
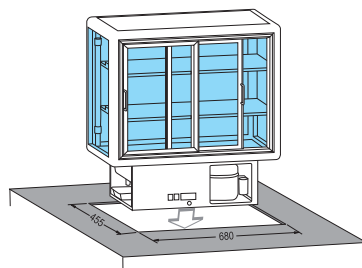
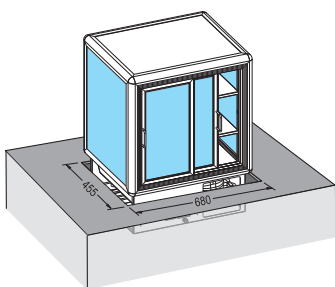

micron II

Neon di serie  
Neon standard



**OPTIONAL:**  
Spot luminoso  
Lighting top



micron I  
(RAL)



micron III  
(RAL)



Termostato meccanico esterno  
Mechanical external thermostat

Termometro meccanico interno  
Mechanical internal thermometer

Colori standard  
Standard colors

Colori optional  
Optional colors



COD. 17



COD. 33



COD. 28



RAL

		°C	mm. (LxPxH)	Lt.	<b>DI SERIE</b>	Watt	% U.R.	DEFROST	H <sub>2</sub> O				Kg.	
Micron I		+4/+10	430x385x734	68	n° 2 mm. 320x350	261	75		MAN	230v/1/50Hz		R134a	28	- di serie
Micron II		+4/+10	430x385x885	93	n° 2 mm. 320x350	261	75		MAN	230v/1/50Hz		R134a	37	- di serie
Micron III		+4/+10	430x385x1105	120	n° 3 mm. 320x350	261	75		MAN	230v/1/50Hz		R134a	40	- di serie

Dati di collaudo • Test details • Détails d'essai • Prüfungsergebnisse • Datos de ensayo • MAX = (25°C - % U.R. 60)

Prezzi vedi LISTINO a pagina 8  
See PRICE LIST on page 8



goloso



Leds di serie  
LEDs standard



Ø mm. 320  
n° 5 ripiani rotanti in vetro  
No. 5 rotating glass shelves

Ultimo ripiano  
a specchio  
Bottom mirror  
shelf

Colori standard  
Standard colors



COD. 13

Colori optional  
Optional colors



RAL



Goloso	+4/+10 °C	mm. (LxPxH) 430x400x1090	Lt. 100	<b>DI SERIE</b> n° 5 Ø mm. 320	Watt 260	% U.R. 75		H <sub>2</sub> O AUT	230v/1/50Hz	R134a	Kg. 44		LED di serie

Dati di collaudo • Test details • Détails d'essai • Prüfungsergebnisse • Datos de ensayo • MAX = (25°C - % U.R. 60)



Prezzi vedi LISTINO a pagina 8  
See PRICE LIST on page 8

junior 120 g



junior 120 gBT



Colori standard  
Standard colors



COD. 01

Colori optional  
Optional colors



COD. 02 RAL

Optional printatura colori legno  
Optional decotation wood colors



COD. 04 COD. 05

		°C	mm. (LxPxH)	Li.	DI SERIE	Watt	% U.R.	DEFROST	H <sub>2</sub> O			Kg.		
Junior 120 G		+2/+10	550x493x1100	120	n° 3 mm. 320x445	450	75		AUT	230v/1/50Hz		R134a	76	Optional LED di serie
Junior 120 GBT		-5/-18	550x493x1100	120	n° 3 mm. 300x430	550	45		MAN	230v/1/50Hz		R404a	78	Optional LED di serie

Dati di collaudo • Test details • Détails d'essai • Prüfungsergebnisse • Datos de ensayo • MAX = (30°C - % U.R. 55)

Prezzi vedi LISTINO a pagina 8  
See PRICE LIST on page 8



MICRON I

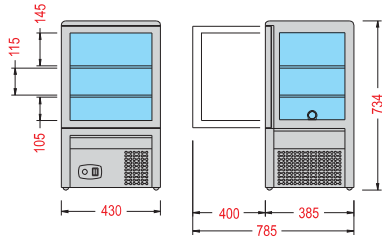

MICRON II

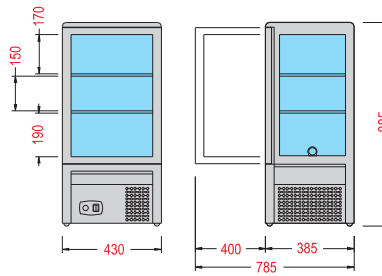

MICRON III

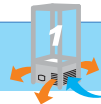
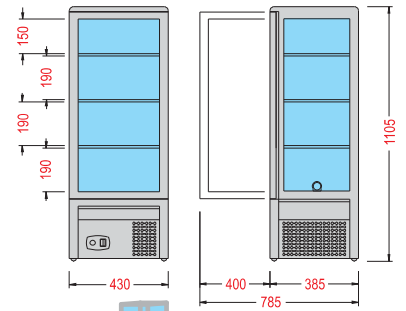

GOLOSO

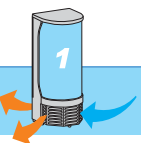
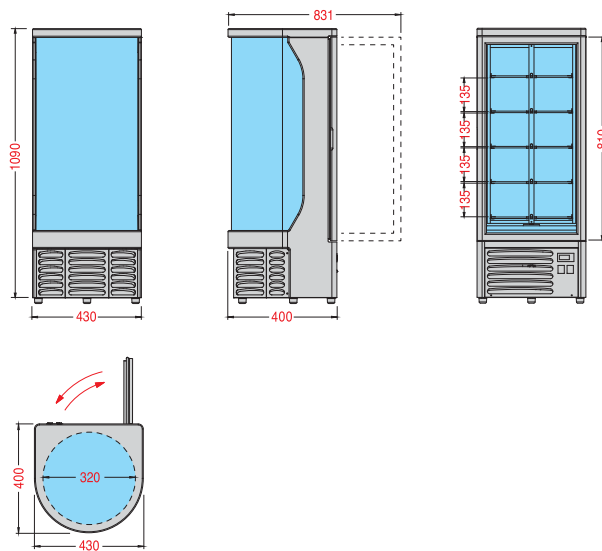

JUNIOR 120 G

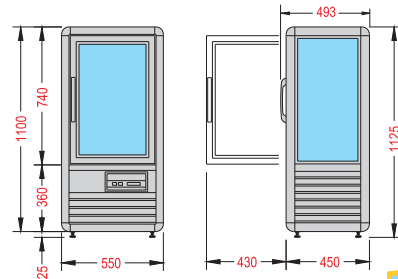

JUNIOR 120 GBT

